

AUTOMATIC SOLUTIONS

SLIM

Wired Intercom System



- Wired audio intercom system.
- Simple install - 2 wires for communication, 2 for gate/door release, 2 for power.
- Up to 4 handsets per system.
- Curved profile stylish handset.
- 150m typical cabled range using twisted pair cables.
- Standard 12v dc powered system.

SLIM

Wired Intercom System

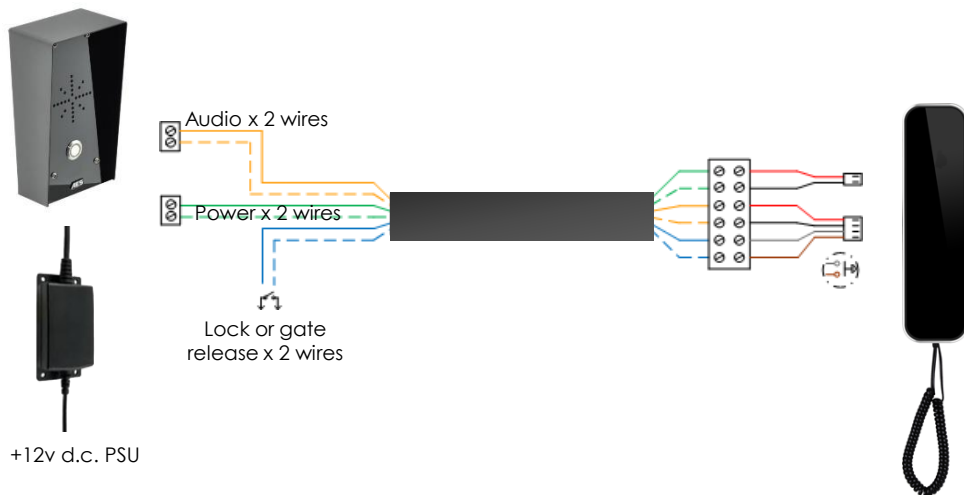

+12v d.c. PSU

Technical Details	
Power	24v dc
Working Distance	150m on 24AWG CAT5 cable
Weather Rating	IP55
Wiring	2 x audio, 2 x power, 2 x door release
Max Handsets	4
Relay Type	N/O momentary 4 second pulse

SLIM

Kits & Part numbers

— SLIM-CL-IMP (Imperial Model)



— SLIM-HF-IMP (Imperial Model)



- Hooded model, for a more traditional yet smart look.
- Ultra stylish all black panel, with textured powder coated aluminium hood, and gloss black acrylic fascia trim over a tough metal back plate.
- Built for tough environments.
- Illuminated push button.
- Kit includes speech panel, handset, power supply and manual.

— SLIM-CL-IMPK (Imperial Model with Keypad)



— SLIM-HF-IMPK (Imperial Model with Keypad)



- Hooded with keypad for a more traditional yet smart look.
- Built in illuminated code-lock keypad for access control.
- Keypad includes 3 relays, 1200 codes, with latching and momentary operation and more.
- Ultra stylish all black panel, with textured powder coated aluminium hood, and gloss black acrylic fascia trim over a tough metal back plate.
- Kit includes speech panel, handset, power supply and manual.

SLIM

Kits & Part numbers

— SLIM-CL-iMP-PED (Industrial Model)



— SLIM-HF-iMP-PED (Industrial Model)



- Industrial model for high volume applications on pedestals, vehicle entrances, etc.
- Super loud 4 watt speaker and sensitive microphone.
- Built for tough environments.
- Illuminated push button.
- Brushed stainless steel construction with gloss acrylic trim.
- Kit includes speech panel, handset, power supply, manual.

— SLIM-CL-iMPK-PED (Industrial Model with Keypad)



— SLIM-HF-iMPK-PED (Industrial Model with Keypad)



- Industrial model for high volume applications on pedestals, vehicle entrances, etc.
- Super loud 4 watt speaker and sensitive microphone.
- Keypad includes 3 relays, 1200 codes, with latching and momentary operation and more.
- Built for tough environments.
- Illuminated push button.
- Brushed stainless steel construction with gloss acrylic trim.
- Kit includes speech panel, handset, power supply and manual.

SLIM

Kits & Part numbers

— SLIM-CL

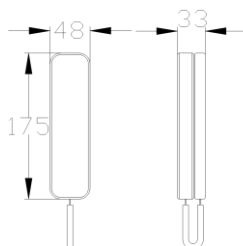

- Add up to 3 extra handsets to any kit (total 4 per system) for larger homes or premises.

— SLIM-HF

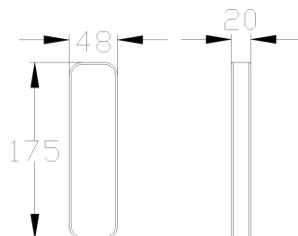

- Add up to 3 extra handsets to any kit (total 4 per system) for larger homes or premises.

— PSU-12V

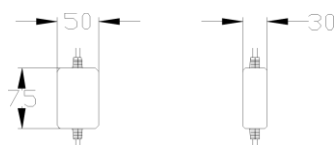

- Additional 12v, 1 amp power supply for longer cable runs, especially required when call point has a keypad and the original PSU is located in the house, or where there are multiple handsets.

Call Panel Dimensions

IMP PANEL

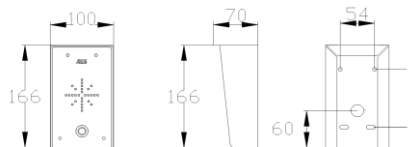

IMPK PANEL

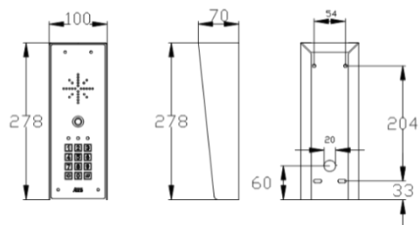

iMP-PED PANEL

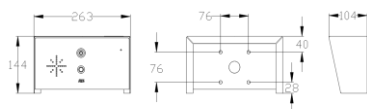

iMPK-PED PANEL

